

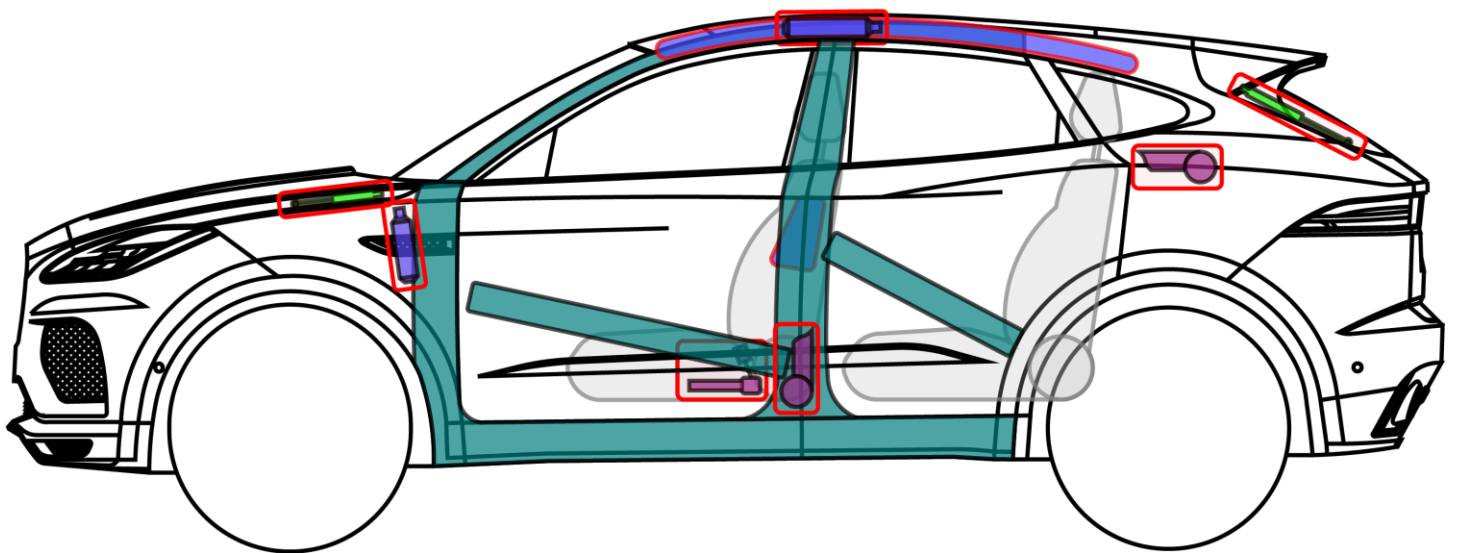







48 Volt Mild Hybrid

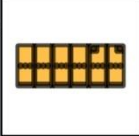

Legende

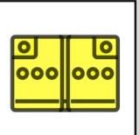
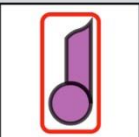
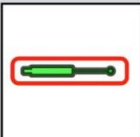
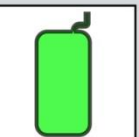
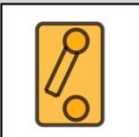
	Airbag		Karosserie- verstärkung		Steuergerät		Hochvolt- batterie
	Gas- generator		Fußgänger- Schutz- system		12 V Batterie		Hochvolt -leitung/ -komponente
	Gurt- straffer		Gasdruck- dämpfer		Kraftstoff- tank		HV- Trennstelle